

C3060 Portable Telephone

User Guide

NORTEL
NETWORKS™ COMPANION



TelephoneMagic.com

C

ontents

Getting started	5
Using your telephone directory	11
Using your services directory	15
Using your headset	19
Customizing your portable	21
Extra features	25
Batteries and charging	32
Accessories for your portable	37
Safety information	38
Technical specifications for USA	41
Caring for your portable	43
Using your C3060 Portable with Meridian Companion	45
Using your C3060 Portable with Companion 200	51
Using your C3060 Portable with Norstar Companion	55

G etting started

Before you use your portable for the first time, see *Safety information* on page 38. You should charge its battery pack overnight (See *All about batteries and recharging* on page 32).

The parts of your portable



Turn the portable on

Press and hold the  button for at least two seconds.

Turn the portable off

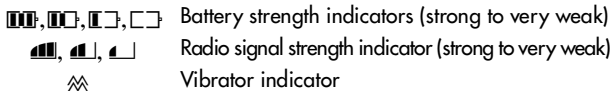

Press the  button for at least two seconds.

Portable screen icons





Note: The three buttons directly below your portable's display are called softkeys. Their labels appear on the display with an underline above the button to which they are assigned. A softkey label is shown like this in this user guide: REDIAL.

Setting your portable to ring

You can set your portable to one of three ring options by pressing the  button when the portable is idle. Select one of the softkeys for FULL, CHIRP, or NONE then press the OK softkey, or press the  button.

FULL provides a normal ring volume and cadence. CHIRP provides one short ring at low volume. NONE provides no audible ring.



Answering a call

Press the  button. When the portable is ringing, you can press the  button to stop the ringing/vibration and continue to answer the call.

Adjusting the ringing volume

When the phone is ringing, you can adjust the ringing volume with the volume switch. When the phone is not ringing, use the Menu to access the volume adjustment levels.

Adjusting the speaker volume

While on a call, pressing  or  can adjust the volume in twelve steps. The steps 0 to 8 raise the volume, with step 0 the lowest volume. The steps 9 to 11 are for noisy environments. The display shows the volume step for two seconds as follows:

- after adjusting the volume
- before making or receiving a call at volume levels 9 to 11

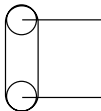

to increase volume press here

to reduce volume press here



Making a call

Dial the telephone number directly or:

- dial from your directory (See *Using your telephone directory* on page 11)
- predial (See *Customizing your portable* on page 21)
- press a customized softkey (See *Customizing softkeys* on page 30)

Accessing features during a call

You can access features or Computer Telephony Integration (CTI) applications while on a call, by three methods:

1. Press , then select the appropriate softkey and dial the access code digits.
2. Select an entry from your Services directory. (See *Using your services directory* on page 15.)
3. Dial a feature from a programmable On-a-call softkey. (See *To assign a number to a softkey when the portable is on a call* on page 30.)

Ending a call

Press the  button.

Making two calls in a row





Press **NEXT** after your first call. The portable maintains its radio connection for another call.

Keeping your connection

To maintain your call, stay in the radio coverage area. If you have problems with your connection, retrace your steps. The signal strength icon  indicates if the signal is becoming stronger or weaker.





Muting a call

To prevent your caller from hearing you, press  on the left side of the portable. The display shows **Microphone muted** and then  in  flashes. To end muting, press  again.

Redialing last number

Your portable is set up so that you can redial the last number you dialed by pressing REDIAL when it appears.

Dialing the last caller

You can view the names of the last two callers when LAST appears on the display. Press LAST and  or  to view the names. Press  to view the number. Press DIAL to call the number or ERASE to delete the number. To add the name to the directory, press SAVE.

U

Using your telephone directory

Storing telephone directory entries

Your portable has an alphanumeric directory that allows you to store up to 100 entries for telephone numbers.

1. Press Ⓜ , ADD.
2. Enter the telephone number, then press SAVE.
3. Enter the first letter of the name by pressing the button that has the letter you want. For example to enter **A**, press ②^{ABC} ; to enter **B**, press $\text{②}^{ABC} \text{②}^{ABC}$. Use ① to choose special characters such as , - ' _ . ()
4. Enter the rest of the letters as shown in step 3. Use ▶ to move the cursor forward if the next letter you want is on the same button, or select SPACE to insert a space.
5. When the name is complete, press SAVE.

Hint: If you want an entry to appear at the start of your directory, make its first character a space using ▶ or other special characters on the ① key.

Find an entry in the telephone directory





Once you have stored entries into the telephone directory, you can move through them quickly by pressing the first letter of the entry you want. For example to look for listings under **D**, press Ⓢ , then 3 DEF ; for listings under **E**, press Ⓢ , then 3 DEF 3 DEF . If there is more than one entry under a letter, press ⏴ to keep looking.

Note: Use 1 to choose special characters such as , - ' _ . ()

Editing telephone directory entries

1. Press Ⓢ , then ⏴ or ⏵ (or the first letter of the entry you want) until you reach the entry you want to change. Directory entries are in alphabetical order.
2. To edit the entry's name press EDIT, then edit the name.
3. Press SAVE.
4. To edit the entry's number press ⏴ , then press EDIT, then edit the number.
5. Press SAVE, ☎ or press Ⓢ .

Deleting an entry

1. Press , then  or .
2. Press ERASE. The display will ask **Erase item?**
3. Press OK. The display will show **Item erased**. (Select CANCEL if you do not want to erase the entry.)
4. Press  or .

Dialing from the telephone directory

Press , find the entry, DIAL.

Pause and link signal

When adding a directory item or customizing a softkey, you may need to insert a pause or a link signal. LINK or FAUSE appears when you are on a call to enable features such as Transfer and Conference.

To insert a pause when you are predialing a number or storing it in your directory, press  and select **Pause**. The display shows **P**.



To insert a link signal, press  and select **Link signal**. The display shows **L**. (See *Using your C3060 Portable with Meridian Companion* or with *Companion 200* or with *Norstar Companion* in this guide for using this feature.)

U

Using your services directory

Your portable has a services directory that allows you to store up to 15 entries for feature codes and Computer Telephony Integration (CTI) applications.

Note: Although the services directory can store telephone numbers, use the services directory for feature codes and CTI applications.

If your system has a CTI server, double clicking the  button displays a pre-programmed menu of CTI applications.

Note: The pre-programmed menu of CTI applications is only available on certain CTI systems.

1. Press , ADD.
2. Enter the feature code or application code, then press SAVE. (See *Using your C3060 Portable with Meridian Companion* or *with Companion 200* or *with Norstar Companion* in this guide for using this feature.) (See the

Storing services directory entries

your system administrator for feature codes to access CTI applications.)

3. Enter the first letter of the name by pressing the button that has the letter you want. For example to enter **A**, press **(2 ABC)**; to enter **B**, press **(2 ABC) (2 ABC)**.
4. Enter the rest of the letters as shown in step 3. Use **(▶)** to move the cursor forward if the next letter you want is on the same button, or select **SPACE** to insert a space.
5. When the name is complete, press **SAVE**.

Hint: If you want an entry to appear at the start of your directory, make the directory entries first character a space using **(▶)** or other special characters on the **(1)** key.

Once you have stored entries into the services directory, you can move through them quickly by pressing the first letter of the entry you want. For example to look at listings under **D**, press **(D)**, then **(3 DEF)**; for listings under **E**, press **(E)**, then **(3 DEF) (3 DEF)**. If there is more than one entry under a letter, press **(↓)** to keep looking.

Note: Use **(1)** to choose special characters such as , - ' _ . ()

Find an entry in the services directory

Pause, link signal and feature request

When adding a directory item, you may need to insert a pause, link or a feature request signal. You can use the feature request signal to enable CTI applications.

Pause

To insert a pause when you are predialing a number or storing a pause in your directory, press **Menu** and select **Pause**. The display shows **P**.

Link signal



To insert a link signal, press **Menu** and select **Link signal** or press **Link** if it is available. The display shows **L**. (See *Using your C3060 Portable with Meridian Companion* or *with Companion 200* or *with Norstar Companion* in this guide for using this feature.)

Feature request signal



To insert a feature request signal, press **Menu** and select **Feature request** or press **Feat** if it is available. The display shows **F**. (See *Using your C3060 Portable with Meridian Companion* or *with Companion 200* or *with Norstar Companion* in this guide for using this feature.)



Editing services directory entries

1. Press , then find an entry. Directory entries are in alphabetical order.
2. To edit the entry's name press EDIT, then edit the name.
3. Press SAVE.
4. To edit the entry's number press , then press EDIT.
5. Press SAVE, .

Deleting an entry

1. Press , then find an entry.
2. Press ERASE. The display will ask **Erase item?**
3. Press OK. The display will show **Item erased**. (Select CANCEL if you do not want to erase the entry.)
4. Press  or .

Press , find an entry, SELCT.

Dialing from the services directory

Using your headset

Use one of the optional headsets to free both hands for other tasks.

Hint: Use the portable with a holster to protect the portable from falls. A holster also allows you free movement while you are on a call.

Connecting and disconnecting the headset



You can disconnect the headset during a call and the call remains on the portable.

Using your portable with the headset

To answer a call, press . To end a call, press .

Note: If you wear a hearing aid, use the C3002 headset to prevent unwanted tones in your hearing aid.



Note: In noisy environments you can use the C3002 headset to provide better voice transmission and reception.

C



ustomizing your portable

Hint: Whenever you are searching through a list, you can press the first letter of the feature, directory, or system entry you want. If there is more than one entry under a letter, press  to keep looking.

To customize your portable, use the **Menu**, which contains a number of features in alphabetical order.

To search through the available options on the **Menu** press ,  or .

Note: The portable displays options in several different ways. Whenever the display shows a heading followed by a colon, as in **Vibrator: On**, you can select the underlined softkey, OFF in this case, to switch to the other option.

Whenever the display shows a heading followed by $\>$, as in **Language>**, press  to enter a menu of options which you can then move through by pressing  or .

Key click

1. Select **Key click**:
2. Choose ON to hear a short beep when you press a button.

Keypad light

Your portable's keypad and display light for low-light conditions. The keypad and display lights independent of keypad light settings when the portable rings.

1. Select **Keypad light**:
2. Choose ON to light the keypad when pressing a key.

You can extend battery life by leaving the keypad light OFF when lighting is not required.

Key-protect



Key protect prevents accidentally pressing the keys.

1. Select **Key-protect**:
2. Choose ON or OFF .

When **Key-protect** is turned on, press START to activate softkeys or buttons on the portable.

Language

1. Select **Language**.



2. Press , then  or  to move between the **In English** and **En français** selections.
3. Press SELECT or SÉL, to select your choice.

Last caller

See *Last caller* on page 26.

Line select

To check that a number is correct before you dial, set up your portable for predialing.

1. Choose **Line select**.
2. Select **MANUAL**, .
3. Enter the telephone number, which may be edited using BACKSP.
4. Press  to dial your call or SAVE to store it in your directory.

Note: You can insert a pause or a link into a predial sequence (See page 13).

Long tones

See *Long tones* on page 26.



Message service

See *Message Service* on page 27





Program softkeys

See *Program softkeys* on page 30





Ringer

1. Select **Ringer**:
2. Press **FULL** for a normal ring volume and cadence.
3. Press **CHIRP** for one short ring at low volume.
4. Press **NONE** for no audible ring.

Ring types

1. Select **Ring types**>.
2. Press ,  or  to hear samples.
3. Press **SELECT** to choose a new ring type, .

Ringer volume



1. Select **Ringer volume**>.
2. Press ,  or , to hear samples or press a number from 1 to 5.
3. Press **SELECT** to choose a new ring volume, .

Vibrator

Select **Vibrator**:. The display shows , and the portable vibrates briefly.



E xtra features

Find a menu item

To search through the available options on the **Menu** press ,  or .

Note: The portable displays options in several different ways.

Whenever the display shows a heading followed by a colon, as in **Vibrator: On**, you can select the underlined softkey, OFF in this case, to switch to the other option.

Whenever the display shows a heading followed by **>**, as in **Language>**, press  to enter a menu of options which you can then move through by pressing  or .

If your system supports features such as Call Forward or Call Transfer, you can customize your Services directory to include them or you can assign them to a softkey (See *Using your services directory* on page 15, *Customizing softkeys* on page 30) and (See *Using your C3060 Portable with Meridian Companion* or *with Companion 200* or *with Norstar Companion* in this guide for using this feature.)

You can put CTI feature codes, or system feature codes, or telephone numbers into your Services directory.

Last caller

If your system supports calling line ID, the last caller list shows the last two incoming calls.

1. Select **Last caller**:
2. Press **LAST** to choose the last caller.
3. Press **SAVE** to save the last caller in the telephone directory.
4. Press **ERASE** to erase the last caller from the last caller list.
5. Press **END** to return to the idle display.

Long tones

1. Select **Long tones**:
2. Choose **ON**,  for long tones to respond to electronic banking services and telephone answering machines. This way you can send a tone that lasts until you take your finger off the button (up to 3 seconds).

Message waiting

Note: Not all systems support this feature. (See your system administrator for features your system supports.)

Some systems allow your portable to display **Message waiting** if you have a voice mail message.

Even if your system does not support Message Waiting indication, you can set up your portable with Message Service to dial directly into your voice mailbox.

Message Service

First, store a message service code. See *To store your message service code* on page 28.

1. Press **MAIL** to access the voice mail system.
2. Press **PLAY** to listen to the message and **NEXT** to move on to the next message.
3. Press **PREV** to listen to the previous message.
4. Press **CALL** to dial the number. Press **DEL** to delete the message.
5. Press **END** to exit your message service.



Note: If you press CALL, and you want to use your active softkeys, press EXIT.

Depending on your voice mail system, you may be required to change the dial codes. Dial codes are the numbers used to access voice mail system features. For example, the default dial code 76 deletes a message. If your voice mail system is Meridian Mail, you do not have to change the dial codes. If you change your message service code, you will have to change the dial codes as required.

To store your message service code

1. Select **Msg service #**, CODE.
2. Enter _____ (your voice mail service access number) and insert one or more pauses as required (See *Pause and link signal* page 13).
3. Enter _____ (your voice mailbox number and password) and press SAVE.

Note: Your voice mail system may require you to press  after you enter your mailbox number or password.

4. The display shows **Dialcodes?**

Note: **Dialcodes?** is only displayed after you first store the message service code. If you erase your message service code, you will have to go through dial codes again and change as required.

Hint: For most Meridian Voice Mail systems, select DEFAULT. For Norstar Companion systems that support integrated voice mail, select NO. On some Norstar Companion systems, message service may work differently. (See your system administrator for assistance.)

5. Press EDIT to change the default dial codes. Press DEFAULT when you do not want to change the dial codes. Press NO when you are not using dial codes.
6. Go through the dial codes and change the values for your voice mail system, if required.

Program softkeys

For direct, one-touch access to frequently used features or frequently called numbers, customize your softkeys.

You can program the softkeys for use when the portable is idle or is on a call.

Softkeys not programmed keep their default values when the portable is idle or is on a call.

The default idle softkeys are REDIAL, MAIL and LAST. The default on a call softkeys are NEXT, LINK and SAVE.

To assign a number to a softkey for use when the portable is idle or on a call

1. Select **Program softkeys**.
2. Press the SELECT softkey.
3. Press the IDLE softkey to use the softkey when the portable is idle or press the On CALL softkey to use the softkey when the portable is on a call.
4. Press the SK - 1, SK - 2, or SK - 3 to select a softkey.

5. Enter a number at prompt **Enter number**; and **SAVE**. You can press **(Menu)** to access **Pause**, **Link signal** or **Feature request**. (See *Pause, link signal and feature request* on page 17.)
6. Enter a key label at prompt **Enter key label** and **SAVE**. Label your softkey with up to four characters by pressing the button that has the letter you want. For example to enter **A**, press **(2 ABC)**; to enter **B**, press **(2 ABC) (2 ABC)**.

To return a customized softkey to the default setting

1. Select **Program softkeys**.
2. Press the **SELECT** softkey.
3. Press the **On CALL** or **IDLE** softkey.
4. Press the **SK - 1**, **SK - 2**, or **SK - 3** to select the softkey you want to return to the default value.
5. Select **new** softkey to redefine another number and label to the softkey. Or select **REDIAL** / **MAIL** / **LAST** / **NEXT** / **LINK** / **SAVE** to return the softkey to the default setting.



Batteries and charging

Important battery information

Before using your rechargeable battery pack for the first time, it must be charged for at least 8 hours. This is necessary to ensure full battery life.

Do not leave your portable or battery pack on a battery charger for extended periods when the batteries are fully charged.

Do not expose the battery packs to temperatures above 40°C/104°F for extended periods.

Your portable needs a rechargeable battery pack. Battery level is shown by the  symbol on the top right of the display. If the batteries are very low, the display flashes  and you hear warning beeps. Your programming will not be lost if you replace your batteries.

Connect the ac adaptor plug of the power cable to the rear of the chargers, then attach the ac adaptor to a power source.

Preparing the chargers

Group Charger

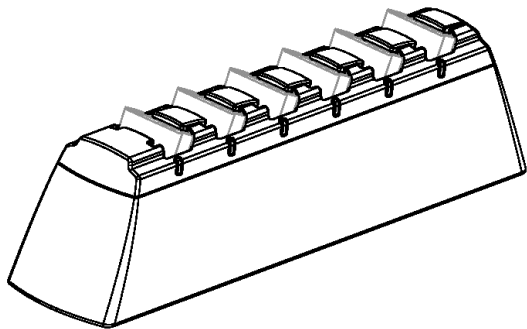

The Companion Group Charger accepts up to six battery packs for charging. Each slot has a LED indicator. Batteries are charged independent of position. For example, the first battery inserted is the first battery charged.

Installing battery packs

Insert the battery pack under the tab in the charger slot.

Individual Charger

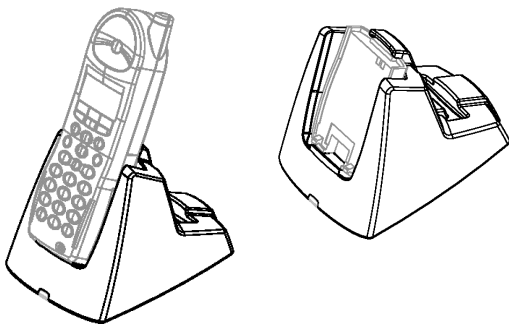

The Companion Individual Charger can charge a handset or a spare battery pack. To charge a separate battery pack in the desktop charger, you must place the battery pack under the tab in the desktop charger.

You can store a spare battery pack in the rear slot of the battery charger. The rear slot is not a charging slot.

Note: All Companion battery chargers will charge all Companion battery packs. Except the Companion C3050 Standard battery charger (A0628269/NTHH06BA) which will not charge the hi-cap (A0628217/NTHH04CA) batteries.

Hint: In high usage environments it is a good idea to have a spare battery pack. Alternating the spare battery pack between charges will prolong battery life.

Companion battery charger LED indications

This table applies to the group and individual battery chargers.

LED	Indication	Description
Red	Fast flashing	Battery defective. Replace the battery
Red	Flashing	Battery charging
Yellow	Flashing	Testing or preparing battery for charging
Green	Steady	Battery fully charged
Off	None	Battery not inserted under the tab correctly

AAA batteries

You can also use an optional AAA battery holder with your portable. Insert the batteries into the battery holder.

Note: The commercially available AAA batteries cannot be charged in any Companion battery charger.

A

ccessories for your portable

The following accessories work with your C3060 portable:

- C3001 Ear Bud Headset
a small and lightweight ear-bud type headset
- C3002 Over-the-head Headset
a full over-the-head band for extra stability and hold with a single earpiece.
- C3050 Clip-on Holster
a custom-designed holster with an adjustable belt clip.
- C3060 Leather Glove
a leather glove that holds the portable with a plastic panel covering the keypad and display.
- C3050 Rugged Protector
a rubber protective case with a built-in rigid black plastic belt clip.

The accessories listed here are available from your Nortel Networks distributor.

Safety information

Electromagnetic energy safety

Hazardous conditions can occur while operating a portable telephone near construction blasting caps or near emergency service radio receivers.

Do not use this portable telephone in locations bearing warning signs that caution against radio transmission.

Follow standard hospital acceptance procedures when using a portable near life-support systems.

Battery safety

Do not replace batteries in a hazardous environment (where sparks are considered dangerous, or where there are flammable gases, flammable liquids, dust, or flammable fumes).

Do not attempt to charge alkaline batteries.

Do not discard batteries in a fire. Batteries can explode when subjected to extremely high temperatures.

Do not place the portable where the battery charging contacts, on the bottom of the portable, will short out. For example, placing the portable in a pocket with loose coins.

Charge the battery pack provided with the portable only in accordance with the instructions specified in this manual.

Antenna safety

The C3060 portable telephone emits low levels of radio energy. Although any risk associated with this energy is minimal, you can further minimize your exposure by not touching the antenna to your face while the portable telephone is turned on.

Charger safety

The C3060 charger power supply is an electrical device containing hazardous voltages. Do not open the power supply or the charger.

Care when using earpiece

Do not place the earpiece next to your ear if a foreign object has become attached to the earpiece.

Note for hearing aid users

Use of the portable telephone can produce an audible tone within a hearing aid. The C3002 headset can be used with hearing aids and will prevent the occurrence of the audible tone.



Technical specifications for USA

Voltage	3.6 V rechargeable batteries 4.5 V (total voltage rating), three AAA alkaline batteries
Frequency band	1.920 to 1.930 GHz
Total channel capacity	99
Operating temperature	14°F to 104°F
RF output power	32 mW ERP maximum

Regulatory compliance

PCI CAI: FCC Etiquette

This device complies with Part 15 of the FCC rules. Operation is subject to the following two conditions:

- 1). This device may not cause harmful interference, and
- 2). This device must accept any interference received, including interference that may cause undesired operation.

Any changes or modifications applied to the portable telephone not expressly approved by Nortel could void the user's authority to operate the equipment.

This portable telephone uses digital encoding to protect the speech transmission.

Privacy

Caring for your portable

Temperature extremes

Avoid subjecting the portable telephone to extremes in temperature.

Care and maintenance

Clean the portable telephone by wiping it with a damp cloth. Do not use solvents or polishes. If your portable telephone does not work, check all charging contacts on the portable and the charger for dirt, grease, or other material. If necessary, clean them with a soft dry cloth.

If your portable drops into a liquid, let the portable dry for two days before using.



Do not spray cleaning or disinfectant solutions on the portable. Spray the solution on a cloth and wipe the portable with the cloth.

Using your C3060 Portable with Meridian Companion



This procedure describes steps to access several features of your portable telephone. Available features vary depending on your telephone system.

Features

Call Forward

1. Press .
2. Enter _____ (flexible feature code).
3. Dial the number to which you want to forward your calls.
4. Press .

Cancel Call Forward

1. Press .
2. Enter _____ (flexible feature code).
3. Press .

Call Park

1. While on a call, press LINK.
2. Enter _____ (flexible feature code).
3. Enter _____ (the number where you want to park the call).
4. Press  to end the current call.

Retrieve a parked call

1. Press .
2. Enter _____ (flexible feature code).
3. Enter the number to which the call was parked.

Conference

1. While on a call with the first party, press LINK.
2. Dial the second number.
3. When your call is answered, press LINK.

Transfer



1. While on a call, press LINK.
2. Dial the second number.
3. When the second number rings, press .

Call Waiting



While you are on a call, your portable beeps to indicate you have another call.

1. Press **LINK** to answer the second call.
2. Press **LINK** again to return to your previous call.

Ring Again

1. When you encounter a busy number, press **LINK**.
2. Enter _____ (flexible feature code).
3. Press . Your portable rings you back when a busy party is free.
4. Press . Your portable automatically places the call.

Cancel Ring Again

1. Press .
2. Enter _____ (flexible feature code).
3. Press .

Speed Call



1. Enter _____ (flexible feature code).
2. Enter _____ (Speed Call code).

System Speed Call

1. Enter _____ (flexible feature code).

2. Enter _____ (System Speed Call code).

Add a link

1. Press ,  or .
2. Select Link signal. The portable will display an L.

Message Waiting

Your portable displays Message waiting if you have a voice mail message. If you have already stored a message waiting code, you can access your messages by selecting CALL. (See page 27 for more information.)

Switch from your portable to your desk telephone

If Wireless Privacy is enabled

- Use Call Transfer.
- Use Conference.

If Wireless Privacy is disabled

- Use your portable as an extension telephone.

Troubleshooting checklist

1. Battery charged? Properly placed?
2. Call Forward canceled?

3. Still having trouble? Call your system administrator.

Other frequently used Feature Codes:

Contact for your system:

Name: _____

Tel #: _____







Using your C3060 Portable with Companion 200

This procedure describes steps to access several features of your portable telephone. Available features vary depending on your telephone system.

Features

Call Forward

1. Press .
2. Enter _____ (Call Forward code).
3. Dial the number to which you want to forward your calls. You may need to wait for a tone.
4. Press .

Cancel Call Forward

1. Press .
2. Enter _____ (Cancel Call Forward code). You may need to wait for a tone.

3. Press .

Call Park

1. While on a call, press LINK.
2. Enter _____ (Call Park code).
3. Press .

Retrieve a parked call

1. Press .
2. Enter _____ (Call Park Retrieval code).
3. Enter the number to which the call was parked.

Conference

1. While on a call with the first party, press LINK.
2. Dial the second number.
3. When your call is answered, press LINK.

Transfer

1. While on a call, press LINK.
2. Dial the second number.
3. When your call is answered, press .

Switch from your portable telephone to your desk telephone:

Troubleshooting checklist

1. Battery charged? Properly placed?
2. Call Forward canceled?
3. Still having trouble? Call your system administrator.

Other frequently used Feature Codes:

Contact for your system:

Name: _____

Tel #: _____

Using your C3060 Portable with Norstar Companion

This procedure describes steps to access several features of your portable.

Note: Underlined text indicates a softkey to use below the display of the C3060 portable.

Making an internal call

1. Dial the number (you may have to press  to select a line).

Making an external call





1. Dial external access code: _____ or enter a line pool code (provided by your installer): _____. (You may have to press  to select a line.)
2. Dial the number.

Features

Transferring using a number

1. While on a call, press LINK.
2. Dial a second internal number.
3. When call is answered, press .

Transferring using the directory

1. While on a call, press LINK.
2. Press .
3. Use  or  or enter a letter to search through the list of entries.
4. Press DIAL when you have made a selection.
5. When call is answered, press .

Using Conference

1. While on a call with the first party, press LINK.
2. Dial a second internal number.
3. When it is answered, press LINK again.

Switching between two calls

While on a call you will hear a beep to indicate an incoming call (call

waiting tone).

1. Answer a second incoming call by pressing LINK. The first caller is put on hold.
2. When you are ready to switch to the other caller, press LINK.

Page

1. Press FEAT (6 MNO 0) or (* (6 MNO 0). The display shows **Page choice:**.
2. To page specific speakers, press SPKR.
or
To page telephone extensions, press SETS.
or
To page speakers and extensions, press BOTH.
3. The display shows **Enter zone:**. Enter the page zone (1 to 6) on the keypad or press ALL.

Note: For systems earlier than MICS-XC 2.0, Page can only be used if an ATA is configured.

To page telephone extensions on systems earlier than MICS-XC 2.0:

1. Press (☎) and enter the line pool code associated with the ATA.

2. Press **LINK** and enter **FEAT** (7PORS) (1) or * (7PORS) (1).
3. Enter the page feature code to use followed by a page zone number (0 to 6).

Language selection

You can change the language for system messages. (See the *Quick Reference Table* for features that use system messages.)

1. To select English for system messages, press **FEAT** (5_JKL) (0) (1) or * (5_JKL) (0) (1).
2. To select French for system messages, press **FEAT** (5_JKL) (0) (2_ABC) or * (5_JKL) (0) (2_ABC).
3. To select Spanish for system messages, press **FEAT** (5_JKL) (0) (3_DEF) or * (5_JKL) (0) (3_DEF).

To change the portable telephone language:

1. Press (Mem) and select **Language**.
2. Press (▶), then (▲) or (▼) to move between the **In English** and the **En français** selections.
3. Press **SELCT** or **SÉL** to select your choice.

Quick Reference Table

You may have to press (☎) to select a line to activate some of the following features.

Enter the feature code you want to use.

Feature	Activation Code
Call Forward	FEAT (4 GHI) or * (4 GHI)
Cancel Call Forward	FEAT # (4 GHI) or * # (4 GHI)
Call Park*	During a call press LINK + FEAT (7PORS) (4 GHI) or * (7PORS) (4 GHI) The portable then displays the call park location
Call Park (retrieve)*	Press LINK and enter the call park location. This is only required when you are on a call.
Call Pickup - directed†	FEAT (7PORS) (6MNO) or * (7PORS) (6MNO) + extension number
Call Pickup - group†	FEAT (7PORS) (5JKL) or * (7PORS) (5JKL)
System Speed Dial	FEAT (0) or * (0) + two digit Speed Dial code
Trunk Answer from any station	FEAT (8TUV) (0) (0) or * (8TUV) (0) (0)
Voice Mail retrieval	FEAT (9WXYZ) (8TUV) (1) or * (9WXYZ) (8TUV) (1)

Feature	Activation Code
Query Voice Mail DN	<u>FEAT</u> 9 ^{WXYZ} 8 ^{TUV} 5 ^{JKL} or * 9 ^{WXYZ} 8 ^{TUV} 5 ^{JKL}
Leave VM Message	<u>FEAT</u> 9 ^{WXYZ} 8 ^{TUV} 0 or * 9 ^{WXYZ} 8 ^{TUV} 0
Intercept Voice Mail	<u>FEAT</u> 9 ^{WXYZ} 8 ^{TUV} 7 ^{PQRS} or * 9 ^{WXYZ} 8 ^{TUV} 7 ^{PQRS}
<p>* These features require MICS-XC 2.0 or later telephone system software.</p> <p>† These features require MICS-XC 3.0 or later telephone system software.</p> <p>The use of the <u>FEAT</u> softkey requires MICS-XC 4.1 or later telephone system software.</p>	

Portable telephone hints

- The softkeys on your C3060 portable operate differently than on your Norstar desk telephone. Some C3060 portable softkeys work with the local features described in this guide.

- Norstar Voice Mail operates by means of your C3060 portable's softkeys during voice mail sessions in MICS-XC 2.0 systems or later.

Troubleshooting checklist

- Batteries charged?
- Batteries properly placed?
- Still problems? Call your system administrator.

Contact for your system:

Name: _____

Tel #: _____



Printed on recycled paper

Copyright © 1999 Nortel Networks
All rights reserved.

Meridian, Norstar and Companion are trademarks of Nortel Networks Corporation.

P0906702
Issue 1.00

Printed in Canada



For more information, visit the Companion homepage at
<http://www.nortel.com/companion>

